

Data Sheet



Article number: 04H081900500250V2

Description: Stabilus IndustryLine stainless steel gas spring size 08/19
250N length 145mm, stroke 50mm Type 04H0819250

Measures

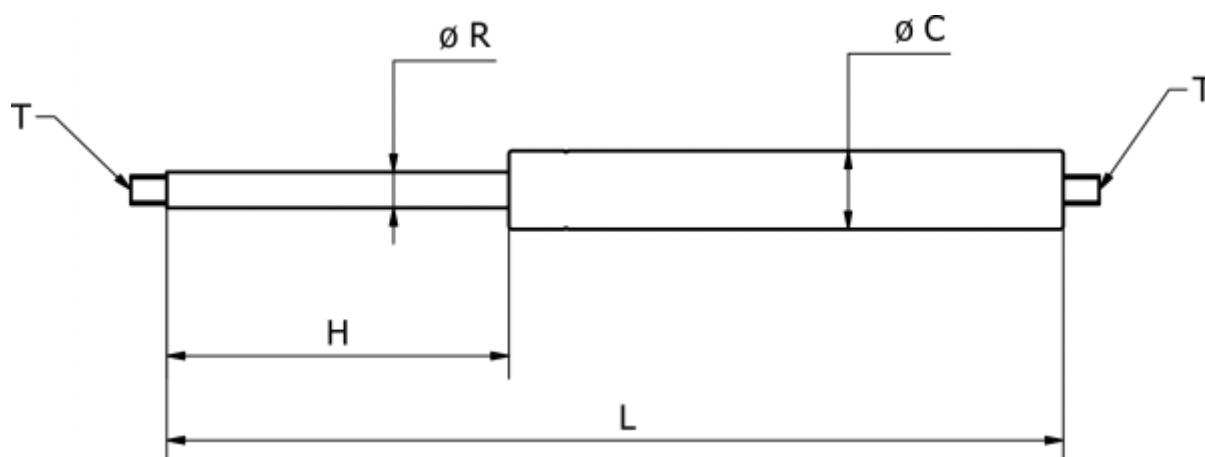

C = 19

H = 50

L = 145

R = 8

T = M8 x 10